

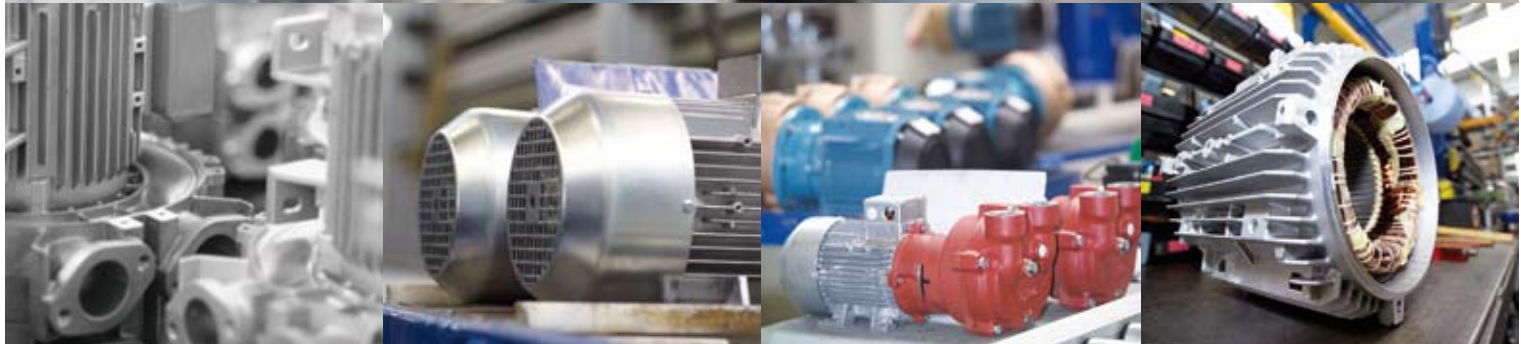

**L-Series** Liquid Ring  
in Monoblock Design



**Elmo  
Rietschle**  
*A Gardner Denver Product*



# Liquid ring vacuum pumps and compressors

## Advantages at a glance

- Monoblock design
- Excellent resistance to corrosion
- No deposits in pump
- No metal-to-metal contact
- Increased water carryover available

Extreme conditions, which prevail in humid and wet processes, lead to lime scale or abrasion, and hence to a considerable reduction in the performance of the pump. Our liquid ring pumps, however, meet these challenges. The use of high quality materials such as stainless steel and ceramics ensure utmost reliability and constant operating characteristics – for years to come.

### Reliable and economical

The L-Series liquid ring vacuum pumps and compressors last longer and are more reliable than modular pumps and will considerably reduce your operating costs.

### Safe and resilient

Our pumps have stainless steel shafts which makes them corrosion resistant. They work safely and reliably even extreme conditions, like those in humid processes.

### No more limescale

The unique ceramic internal coating of the L-Series pump housings means that the pumps will not calcify due to fluid deposits. The special coating has been developed by us in cooperation with our expert partners. The benefit: years of optimal performance at low maintenance cost.

### For use worldwide

The L-Series monoblock pumps feature wide voltage range motors for 50 and 60 Hz in protection class IP55 (insulation class F) and are certified UL 507 and CSA 22.2 No. 113. They can be used all over the world – in Europe, Asia or the Americas.



L-BV3



L-BV7



L-BV2



L-BV5



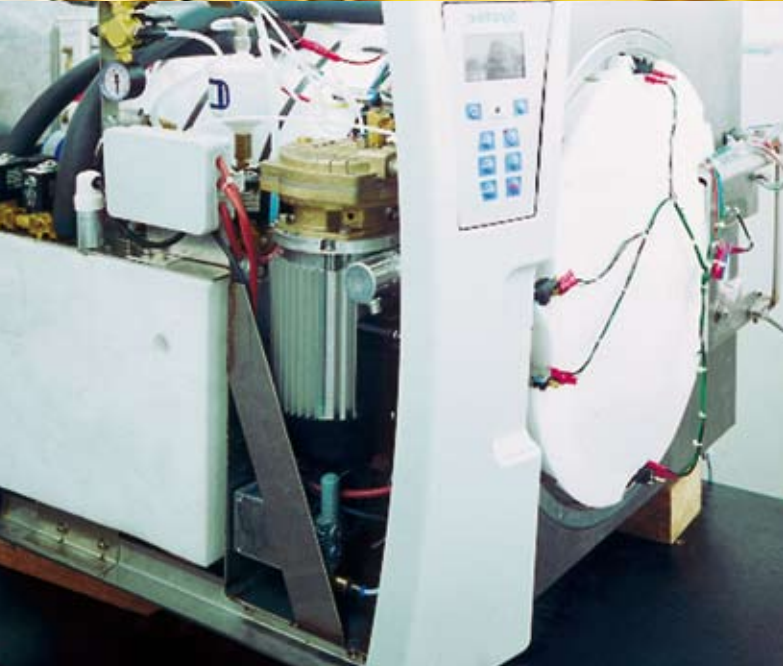

## Applications

### Ceramic and brick industry

- Degassing

### Drying systems

### Environmental engineering

- Filter technology – mobile processing of hydraulic oil
- Recovery of solvents
- Sanitation technology
- Vacuum tankers

### Food and beverage industries

- Central vacuum systems
- Dairy industry
- Filling plants
- Filtering systems
- Food preservation
- Salt water desalination
- Sugar production
- Tobacco humidification
- Water degassing of beverages

### Lifting and handling

### Medical industry

- Central vacuum systems
- Steam sterilization (autoclaves)

### Packaging industry

- Blister pack machines
- Filling and sealing machines
- Filling PET bottles with beer
- Rolling machines

### Plastics industry

- Adhesion of plastic parts
- Calibrating
- Degassing rubber parts
- EPS foaming
- Extruder degassing
- Granulate conveying
- Removal and compression of vinyl chloride gas

# Product overview



L-BV3  

## Performance strength in the smallest space

The L-BV3 liquid ring vacuum pumps are convincing – whether they are used for sterilizers or for medical / laboratory equipment, they excel where extremely small suction capacities are required within a minimum of space. With a suction volume of up to 10,5 m<sup>3</sup>/h, these little workhorses are particularly quiet and consume very little water. It goes without saying, of course, that the L-BV3 can handle suction-side vapors or liquid.

## Advantages at a glance

- Very low noise
- Extremely low water consumption
- Compact
- Integrated cavitation protection
- Safe conveying of vapor and liquids
- High efficiency

L-BV7 / L-BV2   

## Multi-purpose liquid ring pumps

Our L-BV7 and L-BV2 liquid ring pumps are high-powered and multi-talented machines which save space and up to 50 % in operating liquids.

The machines are available in various combinations of materials such as stainless steel, bronze, ceramic and cast iron with ceramic coating. This enables them to be tailored to the respective operating requirements and thus provides long term resistance to erosion and corrosion.

## Advantages at a glance

- Up to 50 % less water consumption
- Pump body also available in full stainless steel
- Extremely quiet and cavitation free
- Long lasting due to ceramic coating
- Reinforced stainless steel shafts in the pump section
- Top quality roller bearings

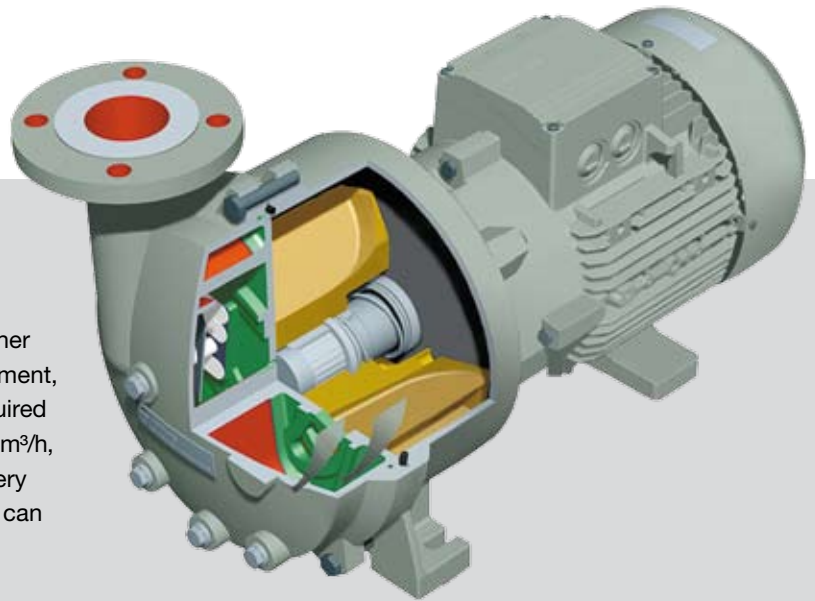

L-BV5   

## Monoblock pumps with the highest volume flow

The block pumps in the L-BV5 family are characterised by a very high suction volume of up to 600 m<sup>3</sup>/h with suction pressures of up to 33 mbar (abs.) and are primarily used for applications with large quantities of liquids. The L-BV5 also simultaneously works as a condenser while suctioning condensable vapor. This enables the suction volume to be doubled. Reinforced stainless steel shafts, continuously lubricated bearings and a coated pump housing prevent wear and tear caused by solids that are also sucked in, and guarantee constant performance, even after many years of use.

## Advantages at a glance

- Low noise and vibration
- Energy saving
- Standard guide ring seals
- Reinforced stainless steel shafts in the pump section
- Long lasting due to ceramic coating
- Top quality roller bearings

# Technical specifications

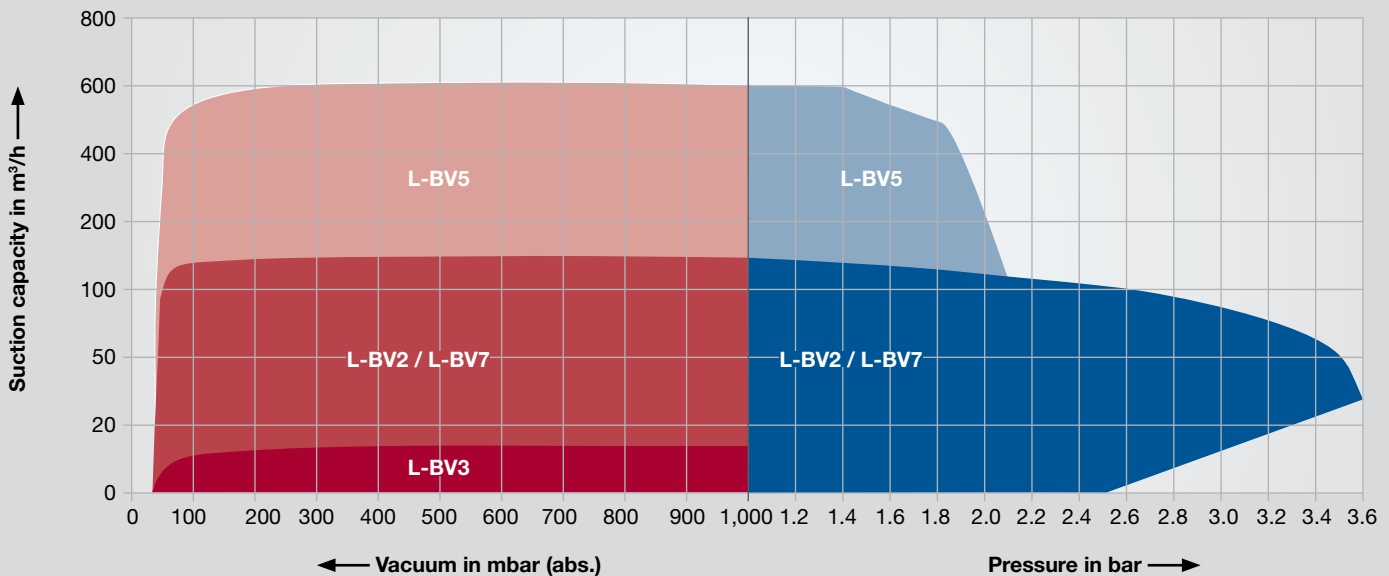

## Operating principle

The impellor (4) is the only moving part inside the pump. It rotates without contact within the pump casing (2). A rotating liquid ring (1) seals the impellor on the front and seals its blades against one another. Through the inlet slot (6) gas flows into the blade cells. In order to keep the liquid ring stable, liquid is also permanently sucked into the compression chamber and is expelled (3) together with the conveyed gas. The excentrical arrangement of the impellor within the casing creates variable compression chambers between the blades (5) during rotation, which causes the conveyed gas to be compressed within a full revolution.

Since the pumps always create a pressure difference during operation, they can also be used as compressors when pumping gas from the surrounding atmosphere. For stable operation, the pumps must be permanently supplied with liquid, which escapes with the conveyed gas on the discharge side. That is why we have developed standardized circuit units as system solutions, which feed the operating liquid that escaped on the discharge side back into the pump. This allows the pump to be operated with a significantly reduced supply of liquid or even without a permanent liquid supply.

Steam components contained in the conveyed gas can condense and be separated. The condensation is accompanied by a decrease in volume, thus enhancing the pumping performance by a condensation factor  $> 1$ .

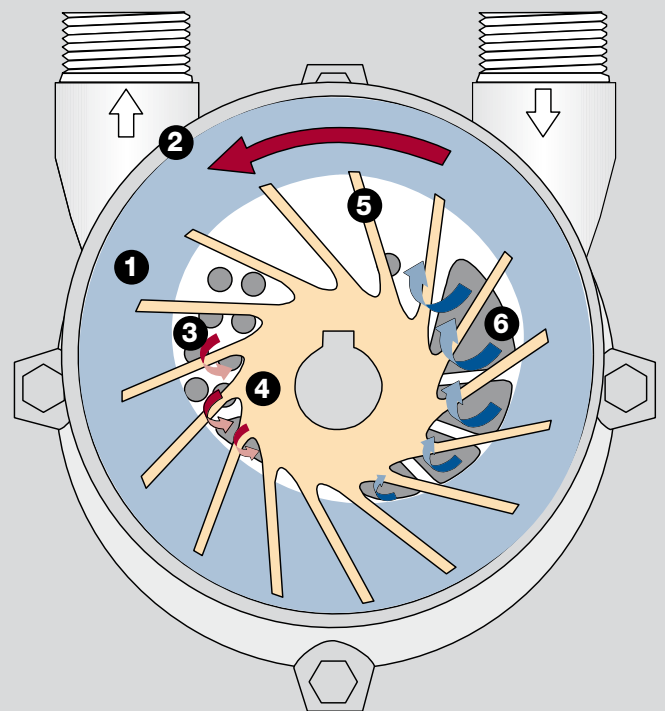



## Technologies for all vacuum and pressure applications



**F-Series** Radial



**G-Series** Side Channel



**L-Series** Liquid Ring



**V-Series** Rotary Vane



**R-Series** Rotary Lobe



**C-Series** Claw



**S-Series** Screw



**X-Series** Systems

[www.gd-elmorietschle.com](http://www.gd-elmorietschle.com)

[er.de@gardnerdenver.com](mailto:er.de@gardnerdenver.com)

**Gardner Denver  
Schopfheim GmbH**  
Roggenbachstraße 58  
79650 Schopfheim · Germany  
Ph. +49 7622 392-0  
Fax +49 7622 392-300

**Gardner Denver  
Deutschland GmbH**  
Industriestraße 26  
97616 Bad Neustadt · Germany  
Ph. +49 9771 6888-0  
Fax +49 9771 6888-4000

**Gardner  
Denver**

Elmo Rietschle is a brand of the  
Gardner Denver Blower Division